

KORTH PRS



PTW KORTH Technologies GmbH, Germany, and the KORTH logo are registered trademarks of PTW KORTH Technologies GmbH, Germany - <http://www.kortharms.com> - and are used for airsoft replicas under worldwide exclusive license from Begadi GmbH - www.begadi.com.

Please read the [Instruction Manual] carefully and make full understanding of the details noted in the contents before use.

WARNING

- To avoid damaging the product, please release the gas from the magazines or cartridges while not operating.
- Sales and usage are restricted to 18-year-old people or older. Those below 18 years old are not allowed neither to purchase nor to operate alone.
- Never aim or shoot at people or animals. Please beware of childrens' mis-handling.
- Please read and fully understand all details listed in this instruction manual before using this air gun. You can download it from www.icsbb.com if you lose this instruction manual.

6mm BB



1 PART DESCRIPTION

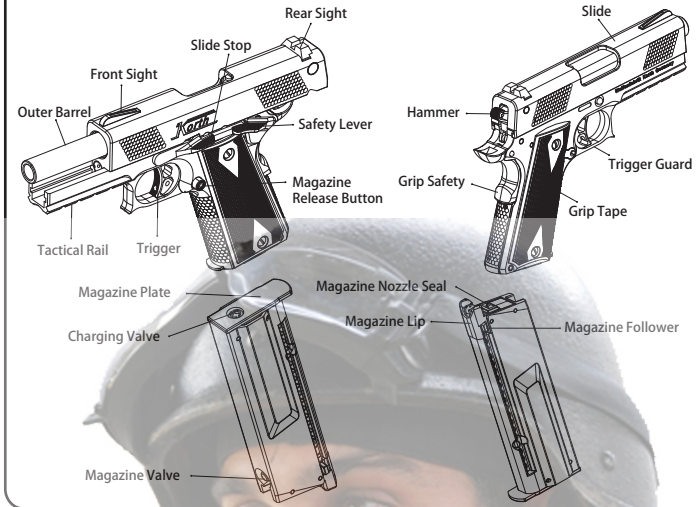

WARNING-ATTENTION



This model is featured with Gas-Blow-Back function. The slide will be pushed back and forth by the gas pressure strongly and rapidly while firing. To prevent injury, please keep your face and finger away from the slide.

● The pistol could be damaged when using at temperature of 35°C (95°F) or above.

2 SAFETY DEVICE

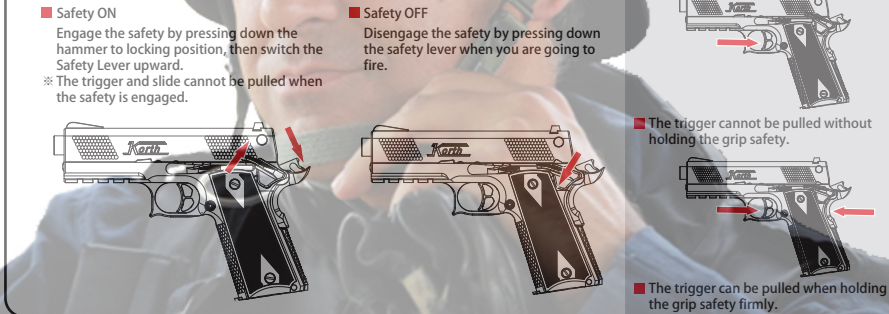

3 LOADING MAGAZINE

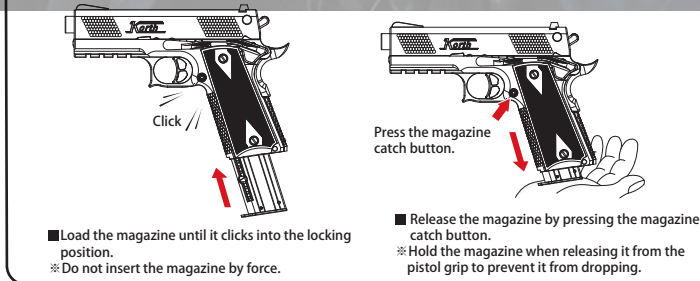

WARNING-ATTENTION

● To prevent misfiring, keep your finger off the trigger and out of the trigger guard while loading the magazine.
 ● For safety reason, please remove the magazine while not operating.

4 CHARGING GAS

For the optimum product performance, please charge your magazine with 10-12kg airsoft use green gas. If you use green gas with non-recommended number of kg, it may cause damage or malfunction to the product.

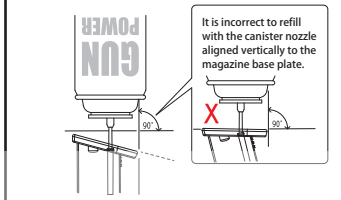

Please turn the magazine up side down to keep the injection hole side up, fill the gas only when the canister is verticalized to the injection hole.
 ※ The gas will not be filled into the magazine or will leak out if the canister is not verticalized to the injection hole.

WARNING-ATTENTION

Precautions while filling:
 ※ If you fill the magazine with a non-vertical way from up towards down, and caused the magazine is not completely filled, please deflate the gas completely, and refill the gas one more time as instructed.
 ※ Fill the gas until the gas starts to leak out. When the gas is fully filled, gas inside the gas canister and magazine are balance without refilling anymore. It is the normal condition that the gas starts to leak out because it is not able to keep filling. Please stop filling immediately.
 △ Please use your magazine under normal temperature!
 ※ If operating in environment of 20°C or below, the gas pressure will drop and might cause abnormal functions. (The magazine will work normally again when temperature returns to normal temperature.)
 ※ If operating in environment of 35°C or above, the gas pressure will be too high and might cause abnormal functions. (The magazine will work normally again when temperature returns to normal temperature.)
 ※ If you fill the magazine with gas and fire dozens of shots even under normal temperature, the gas pressure will also drop and cause the gas temperature to drop. Preparing several spare magazines for exchange is recommended.

5 LOADING BBs

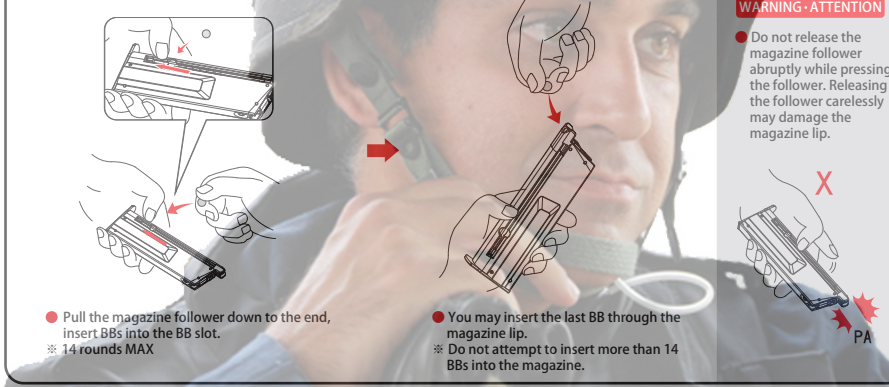

WARNING-ATTENTION

● Do not release the magazine follower abruptly while pressing the follower. Releasing the follower carelessly may damage the magazine lip.

6 Trigger Pull Adjustment

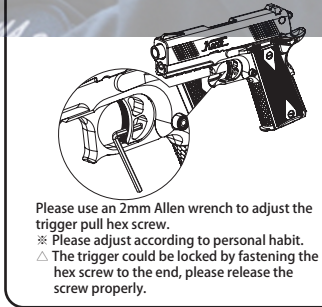

7 Loading

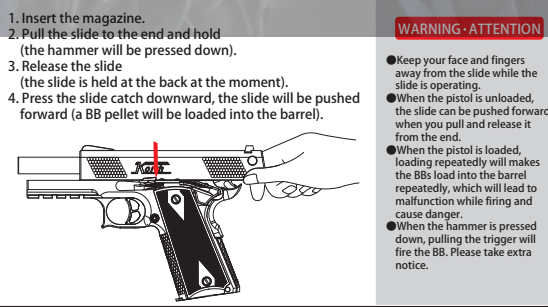

WARNING-ATTENTION

● Keep your face and fingers away from the slide while the slide is operating.
 ● When the pistol is unloaded, the slide can be pushed forward when you pull and release it from the end.
 ● When the pistol is loaded, loading repeatedly will makes the BBs load into the barrel repeatedly, which will lead to malfunction while firing and cause danger.
 ● When the hammer is pressed down, pulling the trigger will fire the BB. Please take extra notice.

8 SHOOTING

- Pressing the safety lever down to FIRE.
- Load the pistol according to step 6.
- Pull the trigger to fire (a BB pellet will be fired and the slide will be pushed backward).

● The slide will be blown back and forth when firing.

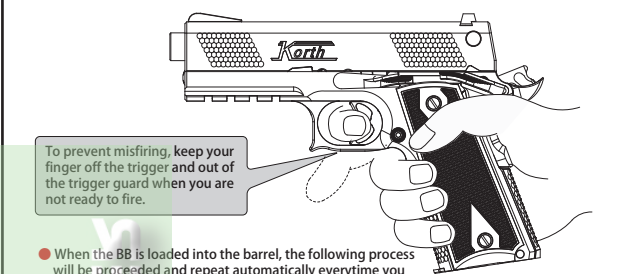

● Shooting posture
 △ Please do not operate the pistol up side down for optium performance.

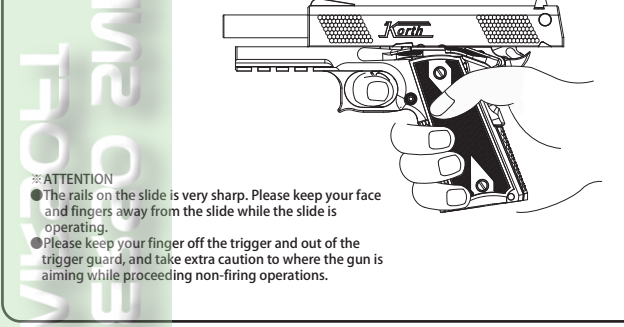

9 STORAGE

- Press the magazine catch button to release the magazine.
- Make sure the inner barrel is clear. If not, pull the slide backward, and turn the pistol up side down to remove the remaining BB, make sure no BBs are left inside the barrel. (push the BB pellet out from the barrel by the clearing rod is recommended).
- Press the slide catch lever to release the slide.
- Pull the trigger towards safety directions to release the hammer.

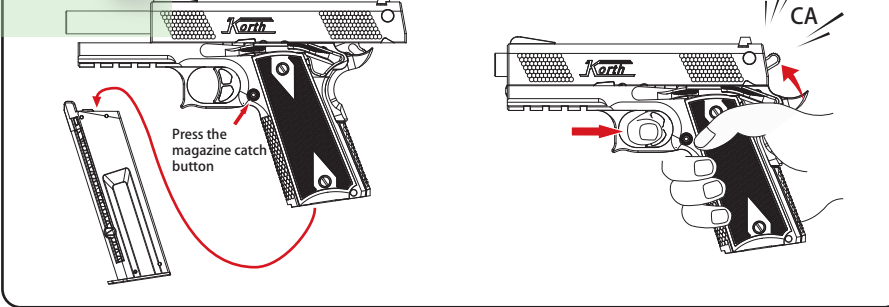

10 DISASSEMBLY (Do it when necessary)

Only disassemble your airsoft replica when adjusting the H-UP and proceeding to maintenance.

① Press the magazine catch to unload the magazine.

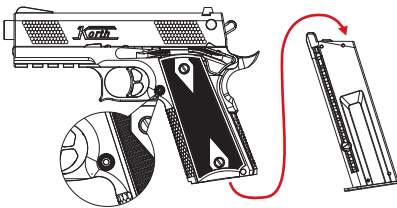

② Pull the slide backward until the slide stop is aligned to the 1st notch from the left as shown.
③ Press the slide stop button on the right to remove the slide stop.

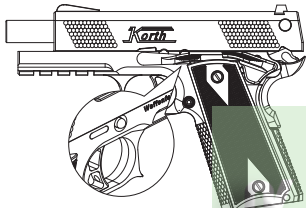

④ Push the slide forward to remove.

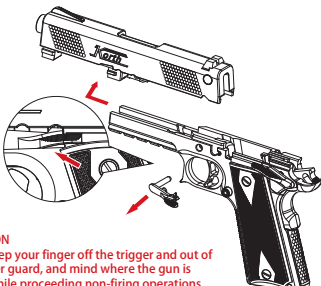

ATTENTION
△ Please keep your finger off the trigger and out of the trigger guard, and mind where the gun is aiming while proceeding non-firing operations.

⑤ Slightly push the outer barrel assembly forward, and then remove it upward.

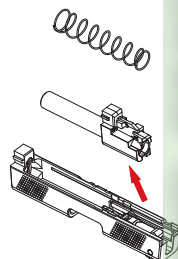

11 H-UP ADJUSTMENT

① Please disassemble and remove the slide as step 9 instructed.
② Slightly rotate the dial to adjust the H-UP.

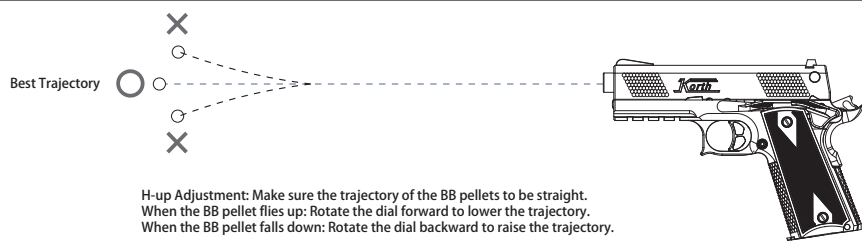
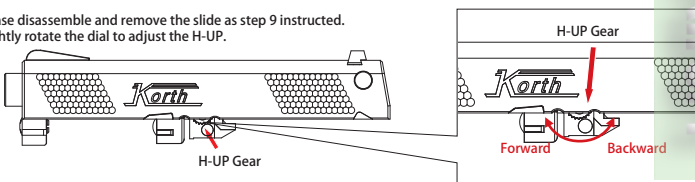

H-up Adjustment: Make sure the trajectory of the BB pellets to be straight. When the BB pellet flies up: Rotate the dial forward to lower the trajectory. When the BB pellet falls down: Rotate the dial backward to raise the trajectory.

12 ASSEMBLY



※ Please check the following status before assembly:
△ The hammer must be down pressed.

① Insert the slide back to the receiver through the rail from the front.
② Pull the slide backward until the slide stop is aligned to the 1st notch from the left as shown.
③ Insert the slide stop back to position, then release the slide.
④ Load the magazine.

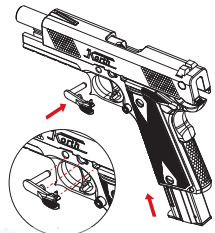

WARNING · ATTENTION

● ICS will not be responsible for any part assembling errors, missing parts, and problems such as malfunctions, accidents, injuries, caused by malfunction, and all the maintaining expenses will be beared by the customer themselves.

13 BASIC TROUBLESHOOTING GUIDE

SYMPTOMS	POSSIBLE CAUSES	SOLUTIONS
No Response	The safety is ON. (No firing)	Switch the safety to "OFF" (refer to step 2)
	Magazine overpressured.	Press the valve gently to release gas and to adjust pressure. Be careful when gas is discharged from the nozzle seal.
	Insufficient gas inside the magazine.	Charge gas into magazine (refer to step 4)
The slide blows back but no BB is fired.	BB can't be loaded into the barrel.	Load the first BB into the barrel (refer to step 6)
	BB is jammed inside the magazine.	Push out the BB by using the clearing rod, or pulling the slide backward, and turn the pistol up side down to remove.
Will not complete cycle	Magazine is too cold.	Use the magazine after it is returned to normal temperature (refer to step 4).
	Temperature is too low.	Use the magazine after it is returned to normal temperature (refer to step 4).
	Magazine is too cold.	Use the magazine after it is returned to normal temperature (refer to step 4).
Slide jammed	No gas in the magazine.	Charge gas into magazine (refer to step 4)
	Lubricant or silicon oil is not enough.	Apply lubricant to the moving aprts.
	BBs or foreign matters jammed inside the slide or frame.	Remove the BBs or foreign matters.
Gas comes out from the barrel	Slide stop is in the locking position.	Pressing down the slide stop to free the slide.
	Temperature is too low.	Use the magazine after it is returned to normal temperature (refer to step 4).
	Magazine is too cold.	Use the magazine after it is returned to normal temperature (refer to step 4).
BBs fly up	H-UP is over adjusted.	Adjust the H-UP gear forward.
Shooting range is too short	H-UP isn't adjusted enough.	Adjust the H-UP gear backward.
	Foreign matters or oil in the inner barrel.	Clean the inner barrel and H-UP bucking.
BBs roll out of barrel	H-UP isn't adjusted enough.	Adjust the H-UP gear forward.
Jammed	H-UP is over adjusted.	Adjust the H-UP gear backward.
	Bad BBs, oversize BBs	0.2g to 0.25g 6mm caliber BBs are recommended for optimum performance.
	Foreign matters or oil in the inner barrel.	Clean the inner barrel.

14 PARTS DIAGRAM

*The components/accessories for each model may have kind of differences depending on the actual goods. Images are only for reference.

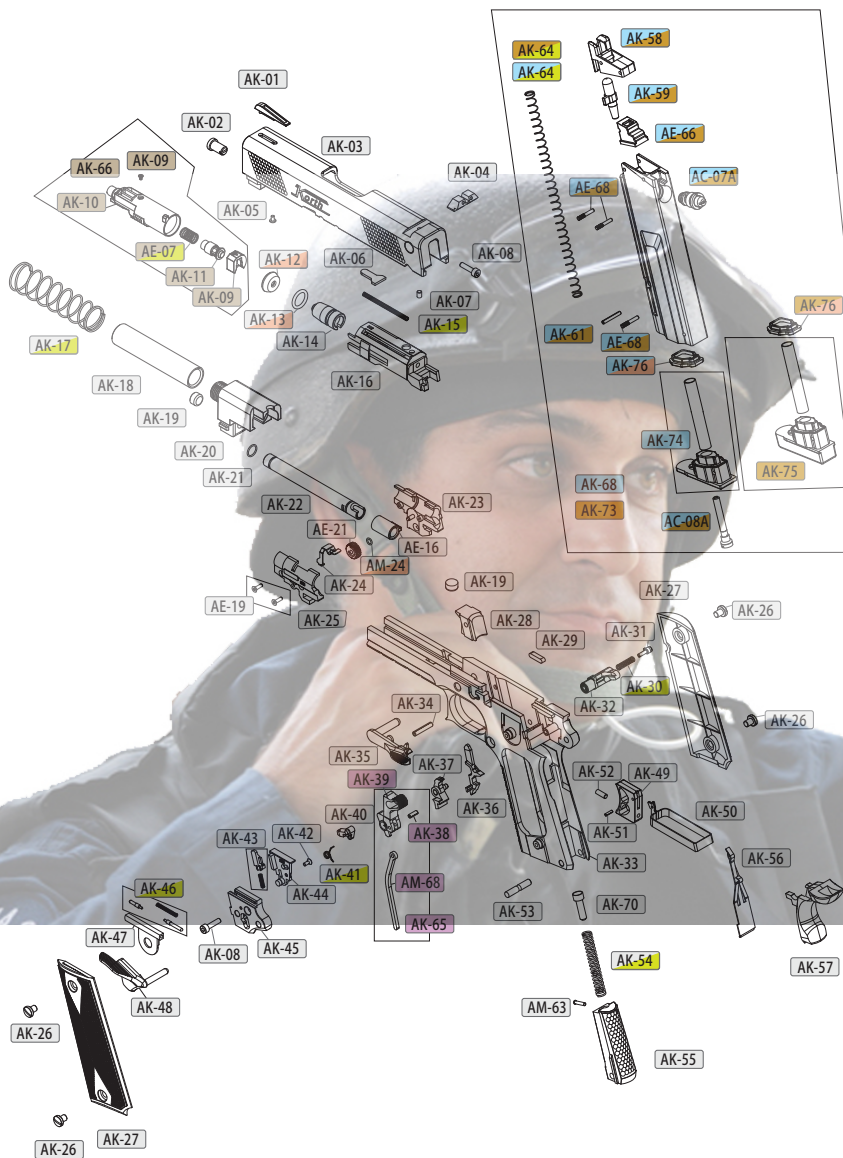

15 PARTS DESCRIPTION

ITEM#	DESCRIPTION	Q'TY	ITEM#	DESCRIPTION	Q'TY
AK-01	PRS Front Sight	1	AK-44	PRS Hammer Disconnect Pin Housing	1
AK-02	Slide Buffer Screw	1	AK-45	PRS Hammer Combination Housing	1
AK-03	PRS Slide-BK	1	AK-46	PRS Slide Catch Lever Pin and Spring	1
AK-04	PRS Rear Sight	1	AK-47	PRS Slide Catch Lever Pin Housing	1
AK-05	Front Sight Screw	1	AK-48	PRS Slide Safety	1
AK-06	PRS Shell Hook	1	AK-49	PRS Trigger	1
AK-07	Rear Sight Screw	1	AK-50	PRS Trigger Bar	1
AK-08	Cylinder Housing and Hammer Screw	2	AK-51	Trigger Bar Pin	1
AK-09	PRS Valve Cover with Screw	1	AK-52	PRS Trigger adjustment Screw	1
AK-10	PRS Cylinder	1	AK-53	PRS Hammer Spring Housing Pin	1
AK-11	PRS Valve	1	AK-54	Hammer Spring	1
AK-12	PRS Valve Plate	1	AK-55	PRS Hammer Spring Housing	1
AK-13	Cylinder Cover Housing O-Ring	1	AK-56	PRS Sear Spring	1
AK-14	PRS Cylinder Cover Housing	1	AK-57	PRS Grip Safety	1
AK-15	PRS Cylinder Housing Spring	1	AK-58	PRS Magazine Lip	1
AK-16	PRS Cylinder Housing	1	AK-59	PRS Magazine Follower	1
AK-17	PRS Recoil Spring	1	AK-60	PRS Magazine Case	1
AK-18	4" PRS Outer Barrel	1	AK-61	Magazine Base Plate Stop Pin	1
AK-19	Slide Buffer	2	AK-62	Magazine Base Plate O-Ring	1
AK-20	PRS Chamber	1	AK-63	Magazine Base-Thin	1
AK-21	Inner Barrel O-Ring	1	AK-64	Magazine Follower Spring	1
AK-22	Inner Barrel (85.5mm)	1	AK-65	PRS Hammer Combination	1
AK-23	PRS H-UP Chamber-Right	1	AK-66	PRS Cylinder Combination	1
AK-24	PRS H-UP Plate	1	AK-67	PRS Spring Package	1
AK-25	PRS H-UP Chamber-Left	1	AK-68	PRS Magazine	1
AK-26	Grip Tape Screw	4	AK-69	O-Ring Parts	1
AK-27	PRS Grip Tape	2	AK-70	PRS Hammer Spring Holder	1
AK-28	PRS H-UP Chamber Holder	1	AK-73	PRS Magazine (Thick Base)	1
AK-29	Serial Number Block	1	AK-74	Magazine Base-Thin	1
AK-30	PRS Magazine Catch Spring	1	AK-75	Magazine Base-Thick	1
AK-31	PRS Magazine Catch Lock	1	AK-76	Magazine Base Plate O-Ring	1
AK-32	PRS Magazine Catch	1	AC-07A	Revo Energy Magazine Valve	1
AK-33	PRS Frame-BK	1	AC-08A	Revo Energy Magazine Nozzle	1
AK-34	PRS H-UP Chamber Holder Pin	1	AE-07	XAE Valve Spring	1
AK-35	PRS Slide Catch Lever Plate	1	AE-16	XAE H-UP Bucking	1
AK-36	PRS Hammer Disconnect Pin	1	AE-19	XAE H-UP Chamber Screw	2
AK-37	PRS Sear with Pin	1	AE-21	H-UP Dial	1
AK-38	Hammer Brace Rod Pin	1	AE-66	XAE Magazine Nozzle Seal	1
AK-39	PRS Hammer	1	AE-68	XAE Magazine Lip Pin	3
AK-40	PRS Hammer Knocker	1	AM-24	O-ring	1
AK-41	PRS Hammer Knocker Spring	1	AM-63	BM9 Hammer Spring Holder Pin	1
AK-42	Hammer Housing Screw	1	AM-68	BM9 Hammer Brace Rod	1
AK-43	PRS Hammer Disconnect Pin and Spring	1			